



20N65-ML

Power MOSFET

20A, 650V N-CHANNEL POWER MOSFET

DESCRIPTION

The UTC **20N65-ML** is a N-channel mode power MOSFET using UTC's advanced technology to provide customers with a minimum on-state resistance, high switching speed, low gate charge and low input capacitance.

The UTC **20N65-ML** is universally applied in high efficiency switch mode power supply.

FEATURES

- * $R_{DS(ON)} \leq 0.43 \Omega @ V_{GS}=10V, I_D=10A$
- * High Switching Speed

SYMBOL

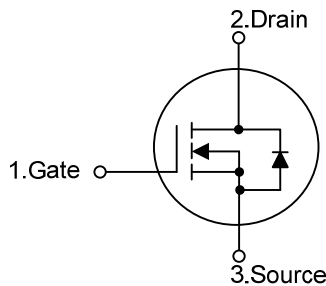

ORDERING INFORMATION

Ordering Number		Package	Pin Assignment			Packing
Lead Free	Halogen Free		1	2	3	
20N65L-ML-TF1-T	20N65G-ML-TF1-T	TO-220F1	G	D	S	Tube
20N65L-ML-TF2-T	20N65G-ML-TF2-T	TO-220F2	G	D	S	Tube
20N65L-ML-T3P-T	20N65G-ML-T3P-T	TO-3P	G	D	S	Tube
20N65L-ML-T3N-T	20N65G-ML-T3N-T	TO-3PN	G	D	S	Tube
20N65L-ML-T47-T	20N65G-ML-T47-T	TO-247	G	D	S	Tube

Note: Pin Assignment: G: Gate D: Drain S: Source

<p>20N65G-ML-TF1-T</p>	<p>(1) T: Tube, R: Tape Reel (2) TF1: TO-220F1, TF2: TO-220F2, TF3: TO-220F, T2Q: TO-262, TQ2: TO-263, T3P: TO-3P, T3N: TO-3PN, T47: TO-247, T474: TO-247-4 (3) Version ML (4) G: Halogen Free and Lead Free, L: Lead Free</p>
------------------------	---

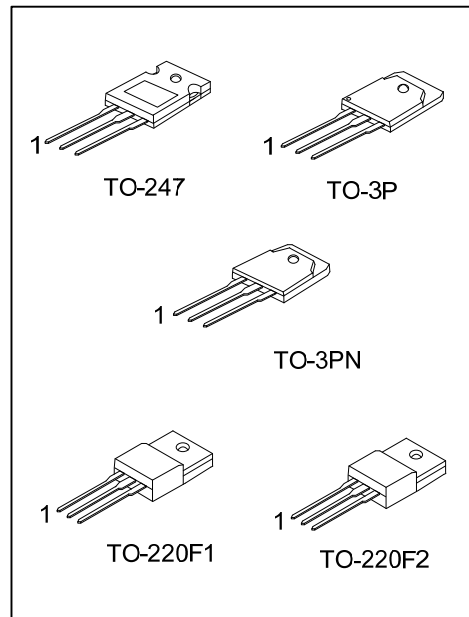

MARKING

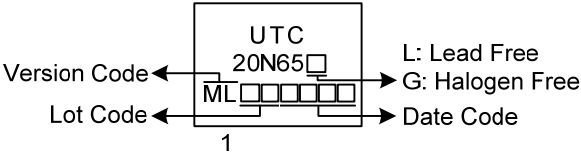

■ ABSOLUTE MAXIMUM RATINGS (unless otherwise specified)

PARAMETER		SYMBOL	RATINGS	UNIT
Drain-Source Voltage		V_{DSS}	650	V
Gate-Source Voltage		V_{GSS}	± 30	V
Continuous Drain Current	Continuous	I_D	20	A
	Pulsed	I_{DM}	40	A
Single Pulsed Avalanche Energy		E_{AS}	653	mJ
Peak Diode Recovery dv/dt (Note 4)		dv/dt	2.5	V/ns
Power Dissipation	TO-220F1	P_D	42	W
	TO-220F2			
	TO-3P/TO-3PN		270	W
	TO-247		260	W
Junction Temperature		T_J	+150	$^{\circ}\text{C}$
Storage Temperature		T_{STG}	-55 ~ +150	$^{\circ}\text{C}$

Notes: 1. Absolute maximum ratings are those values beyond which the device could be permanently damaged.

Absolute maximum ratings are stress ratings only and functional device operation is not implied.

2. Repetitive Rating: Pulse width limited by maximum junction temperature.

3. $L = 30\text{mH}$, $I_{AS} = 6.6\text{A}$, $V_{DD} = 50\text{V}$, $R_G = 25\Omega$, Starting $T_J = 25^{\circ}\text{C}$

4. $I_{SD} \leq 20\text{A}$, $di/dt \leq 200\text{A}/\mu\text{s}$, $V_{DD} \leq BV_{DSS}$, Starting $T_J = 25^{\circ}\text{C}$

■ THERMAL CHARACTERISTICS

PARAMETER		SYMBOL	RATINGS	UNIT
Junction to Ambient	TO-220F1	θ_{JA}	62.5	$^{\circ}\text{C}/\text{W}$
	TO-220F2			
	TO-3P/TO-3PN		40	$^{\circ}\text{C}/\text{W}$
	TO-247		40	$^{\circ}\text{C}/\text{W}$
Junction to Case	TO-220F1	θ_{JC}	2.98	$^{\circ}\text{C}/\text{W}$
	TO-220F2			
	TO-3P/TO-3PN		0.46	$^{\circ}\text{C}/\text{W}$
	TO-247		0.48	$^{\circ}\text{C}/\text{W}$

■ ELECTRICAL CHARACTERISTICS

PARAMETER	SYMBOL	TEST CONDITIONS	MIN	TYP	MAX	UNIT
OFF CHARACTERISTICS						
Drain-Source Breakdown Voltage	BV_{DSS}	$I_D=250\mu A, V_{GS}=0V$	650			V
Drain-Source Leakage Current	I_{DSS}	$V_{DS}=650V, V_{GS}=0V$			10	μA
Gate-Source Leakage Current	Forward	$V_{GS}=+30V, V_{DS}=0V$			+100	nA
	Reverse	$V_{GS}=-30V, V_{DS}=0V$			-100	nA
ON CHARACTERISTICS						
Gate Threshold Voltage	$V_{GS(TH)}$	$V_{DS}=V_{GS}, I_D=250\mu A$	2.0		4.0	V
Static Drain-Source On-State Resistance	$R_{DS(ON)}$	$V_{GS}=10V, I_D=10A$			0.43	Ω
DYNAMIC PARAMETERS						
Input Capacitance	C_{ISS}	$V_{GS}=0V, V_{DS}=25V, f=1.0MHz$		3315		pF
Output Capacitance	C_{OSS}			258		pF
Reverse Transfer Capacitance	C_{RSS}			10		pF
SWITCHING PARAMETERS						
Total Gate Charge	Q_G	$V_{DS}=520V, V_{GS}=10V, I_D=20A$ (Note 1, 2)		80		nC
Gate to Source Charge	Q_{GS}			40		nC
Gate to Drain Charge	Q_{GD}			20		nC
Turn-ON Delay Time	$t_{D(ON)}$	$V_{DD}=100V, V_{GS}=10V, I_D=20A,$ $R_G=25\Omega$ (Note 1, 2)		35		ns
Rise Time	t_R			20		ns
Turn-OFF Delay Time	$t_{D(OFF)}$			205		ns
Fall-Time	t_F			51		ns
SOURCE- DRAIN DIODE RATINGS AND CHARACTERISTICS						
Maximum Body-Diode Continuous Current	I_S				20	A
Maximum Body-Diode Pulsed Current	I_{SM}				40	A
Drain-Source Diode Forward Voltage	V_{SD}	$I_S=20A, V_{GS}=0V$			1.4	V
Body Diode Reverse Recovery Time	t_{rr}	$I_S=20A, V_{GS}=0V, di_F/dt=100A/\mu s$ (Note 1)		470		ns
Reverse Recovery Charge	Q_{rr}				8	

Notes: 1. Pulse Test: Pulse width $\leq 650\mu s$, Duty cycle $\leq 2\%$.

2. Essentially independent of operating temperature.

■ TEST CIRCUITS AND WAVEFORMS

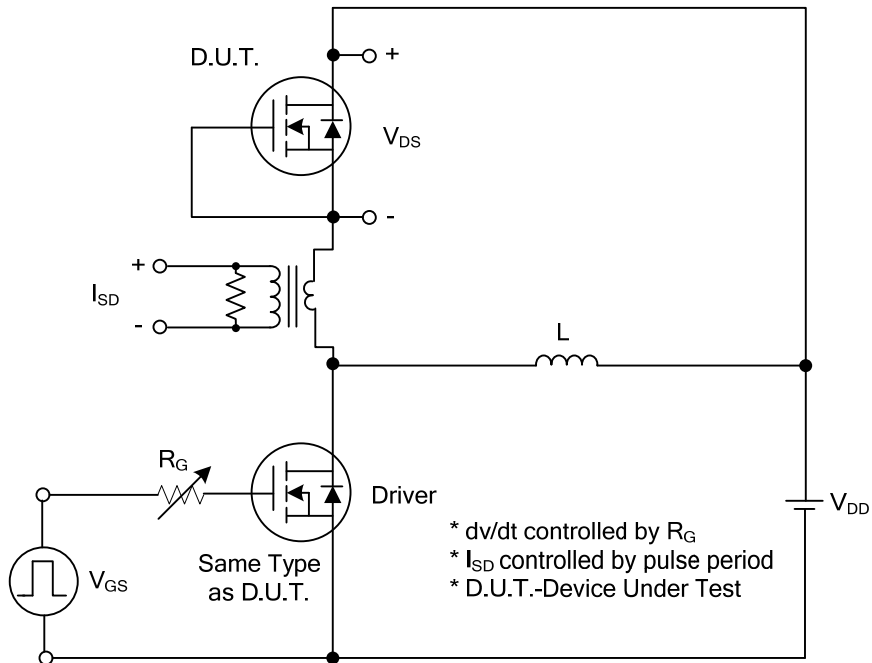

Peak Diode Recovery dv/dt Test Circuit

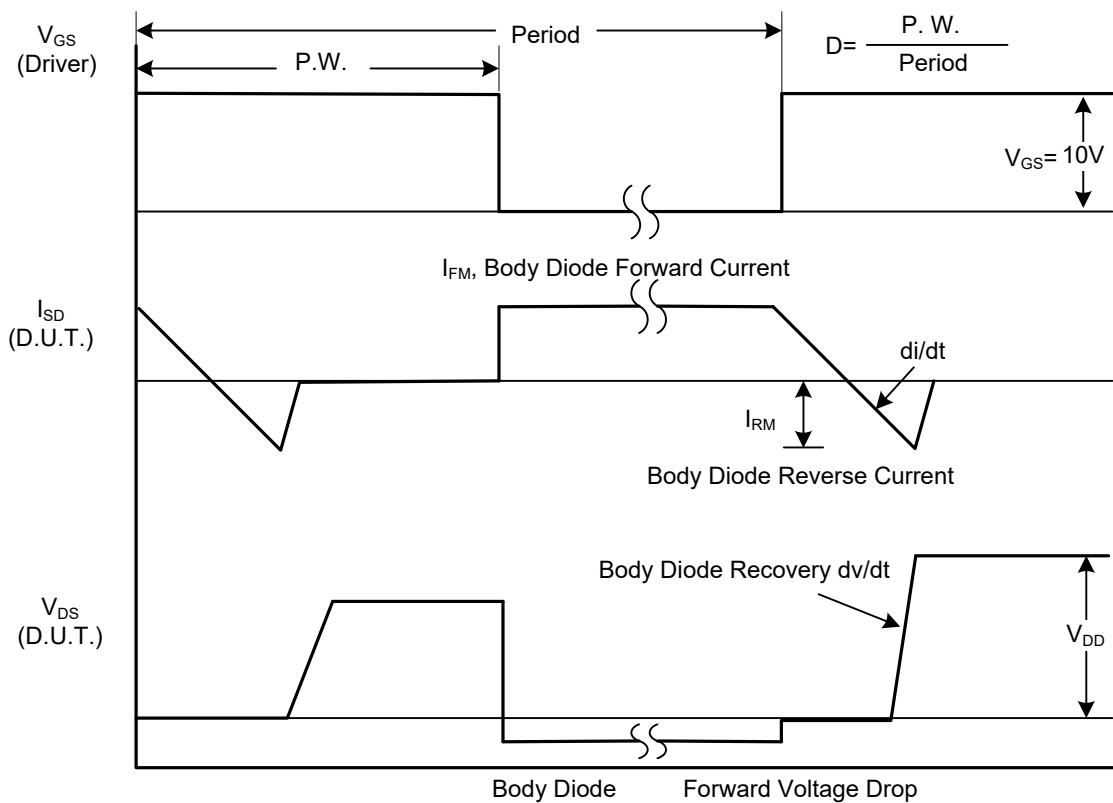

Peak Diode Recovery dv/dt Waveforms

TEST CIRCUITS AND WAVEFORMS

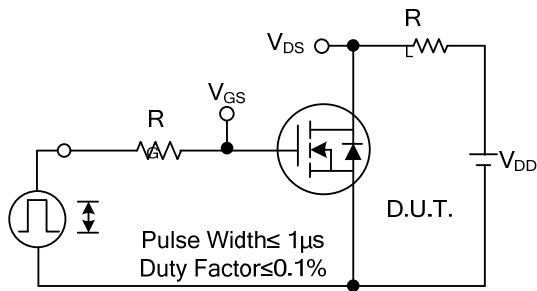

Switching Test Circuit

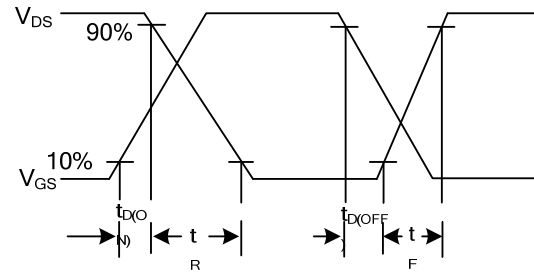

Switching Waveforms

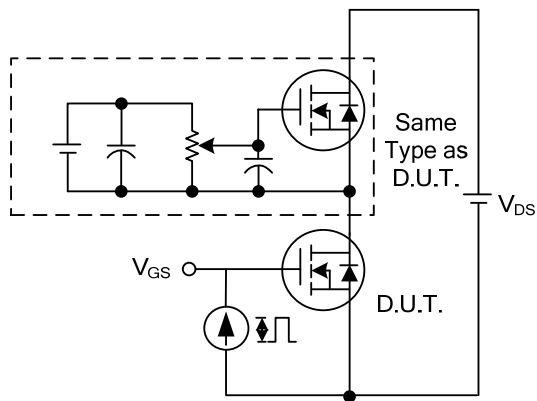

Gate Charge Test Circuit

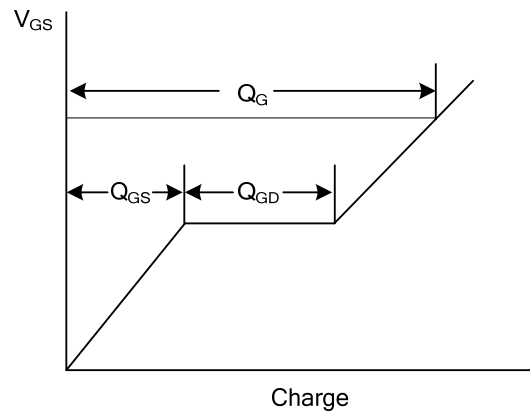

Gate Charge Waveform

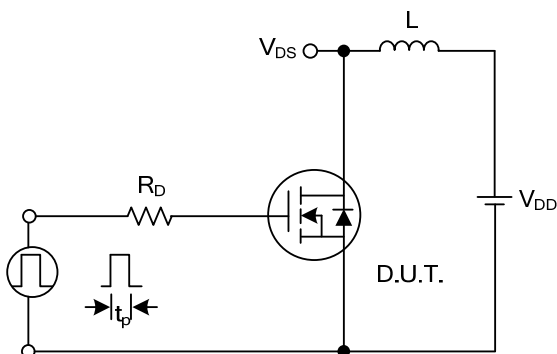

Unclamped Inductive Switching Test Circuit

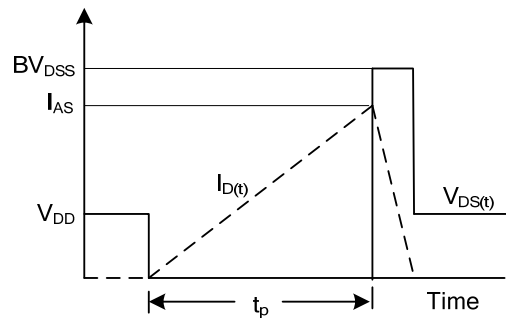

Unclamped Inductive Switching Waveforms

■ TYPICAL CHARACTERISTICS

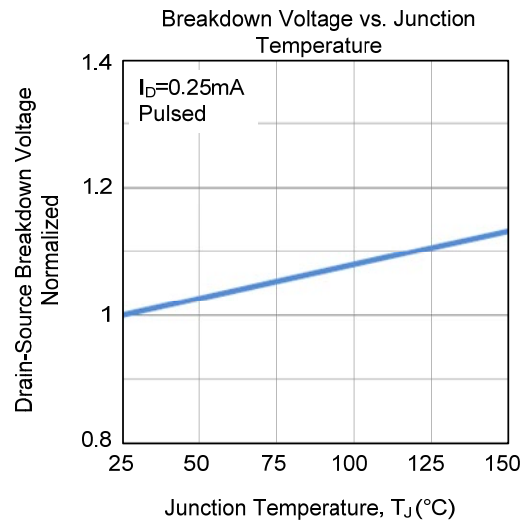
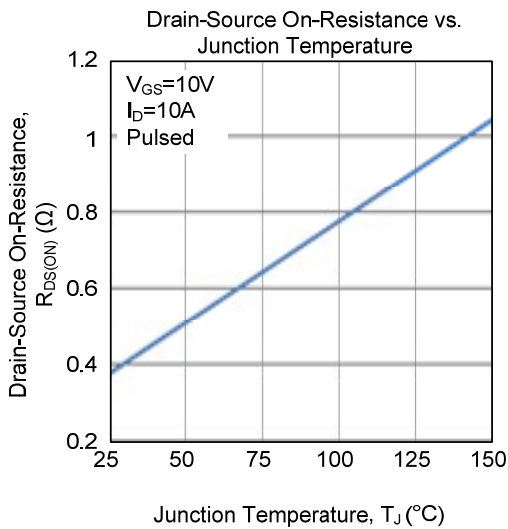
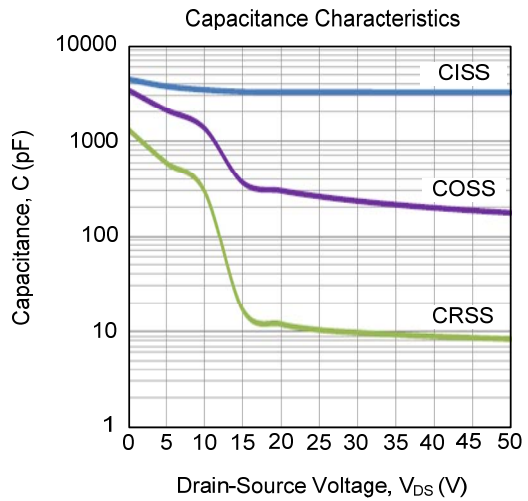
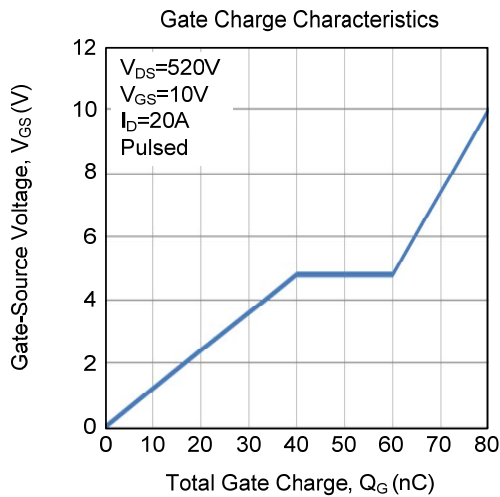
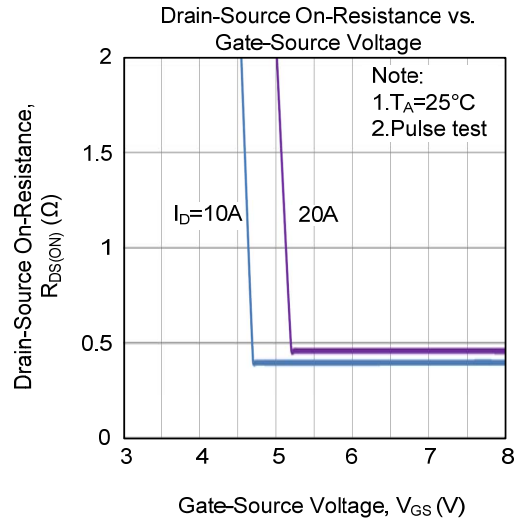
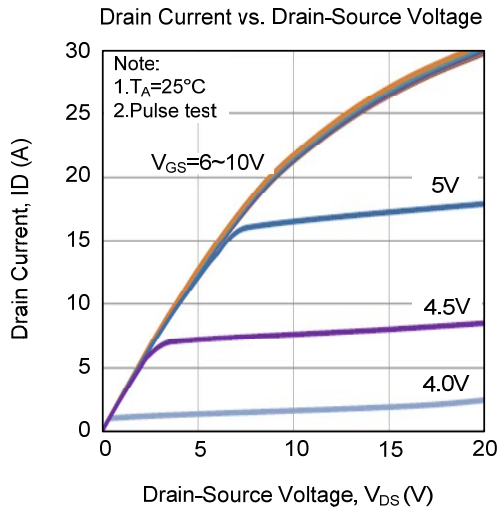

■ TYPICAL CHARACTERISTICS (Cont.)

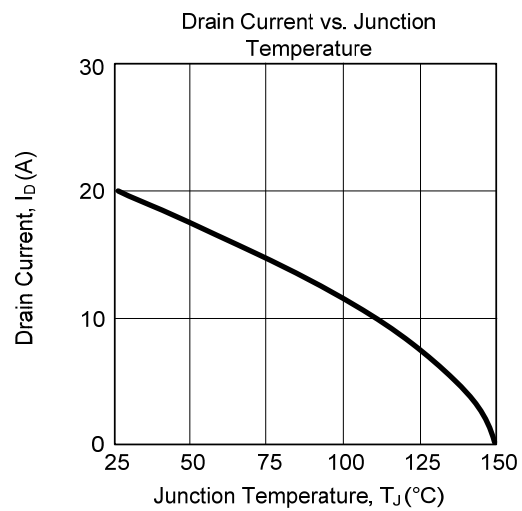
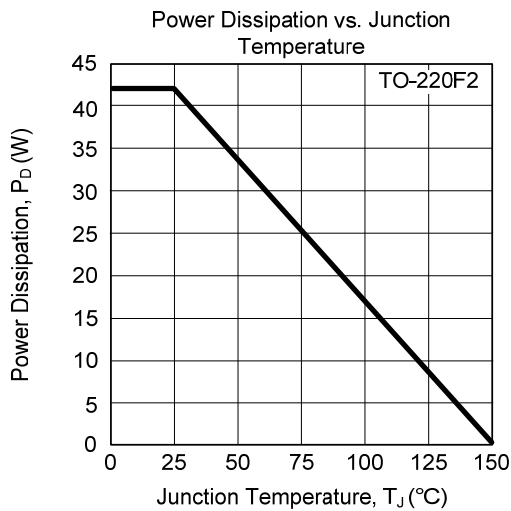
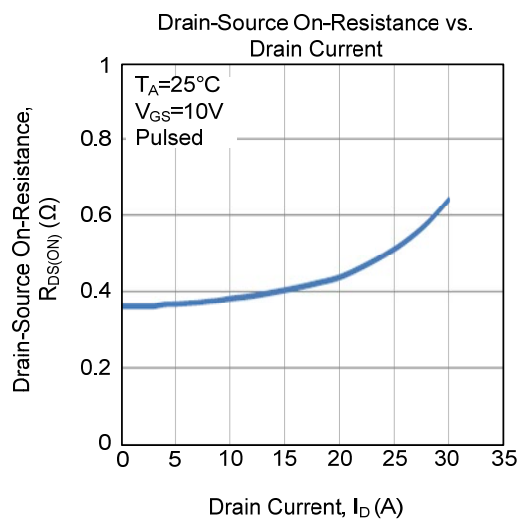
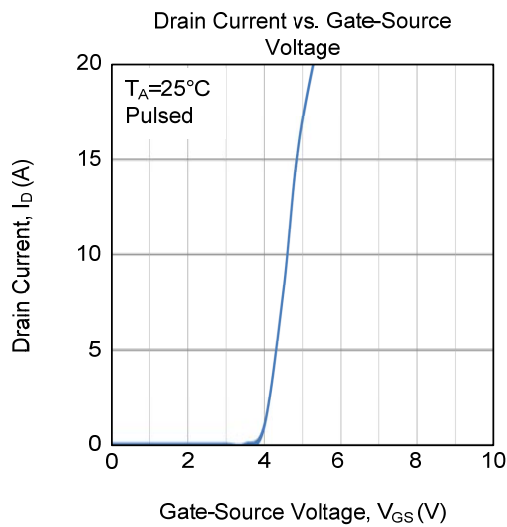
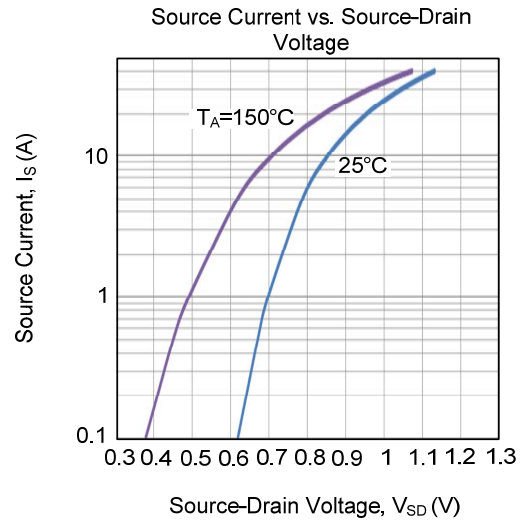
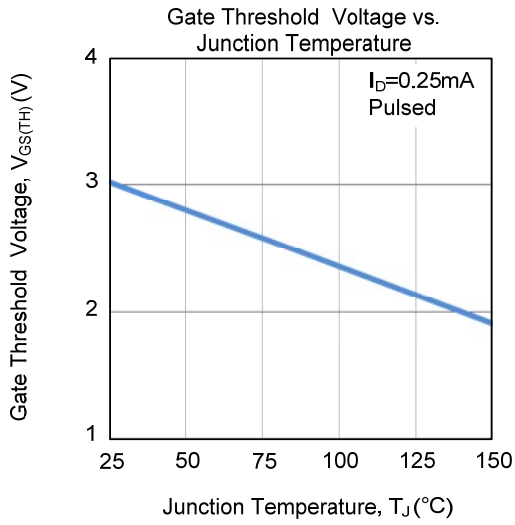

■ TYPICAL CHARACTERISTICS (Cont.)

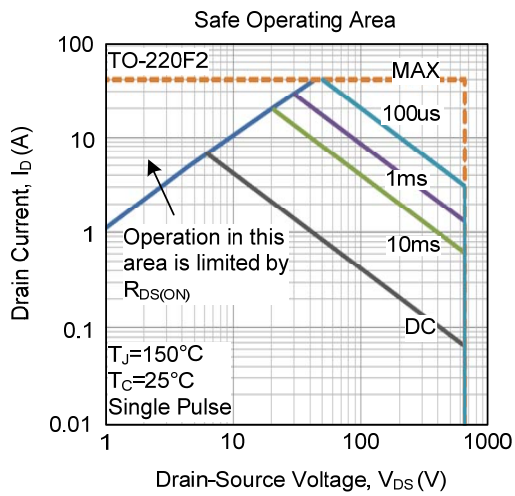

UTC assumes no responsibility for equipment failures that result from using products at values that exceed, even momentarily, rated values (such as maximum ratings, operating condition ranges, or other parameters) listed in products specifications of any and all UTC products described or contained herein. UTC products are not designed for use in life support appliances, devices or systems where malfunction of these products can be reasonably expected to result in personal injury. Reproduction in whole or in part is prohibited without the prior written consent of the copyright owner. UTC reserves the right to make changes to information published in this document, including without limitation specifications and product descriptions, at any time and without notice. This document supersedes and replaces all information supplied prior to the publication hereof.