



BTA304A

TRIAC

4A TRIACS

■ **DESCRIPTION**

The UTC **BTA304A** is a 4A triacs which can be operated in 3 quadrants only, it uses UTC's advanced technology to provide customers with high commutation performances, etc.

The UTC **BTA304A** is suitable for inductive load switching operations, also can be used in ON/OFF function applications such as induction motor starting circuits, heating regulation, static relays etc.

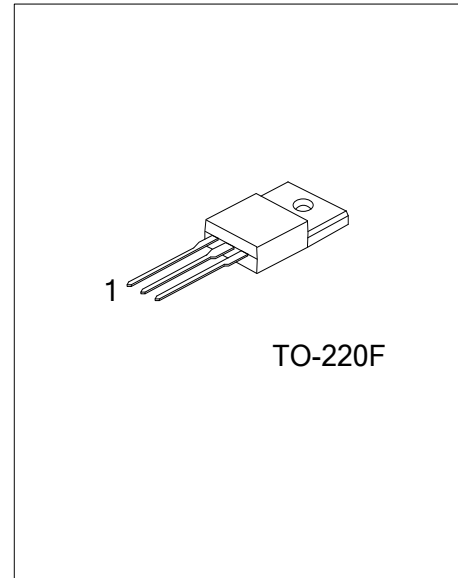

■ **SYMBOL**

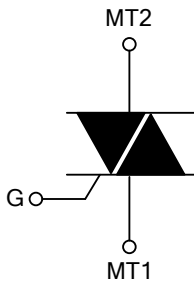

■ **ORDERING INFORMATION**

Ordering Number		Package	Pin Assignment			Packing
Lead Free	Halogen Free		1	2	3	
BTA304AL-x-xx-TF3-T	BTA304AG-x-xx-TF3-T	TO-220F	MT1	MT2	G	Tube

Note: Pin Assignment: MT1: MT1 MT2: MT2 G: Gate

BTA304AG-x-xx-TF3-T		
(1)Packing Type	(1) T: Tube	
(2)Package Type	(2) TF3: TO-220F	
(3)Sensitivity and type	(3) refer to SENSITIVITY AND TYPE	
(4)Voltage	(4) 6: 600V	
(5)Green Package	(5) G: Halogen Free and Lead Free, L: Lead Free	

■ **SENSITIVITY AND TYPE**

PART NUMBER	VOLTAGE		SENSITIVITY	TYPE
	600V	800V		
CW	⊙	⊙	35mA	SNUBBERLESS
SW	⊙	⊙	10mA	LOGIC LEVEL

⊙: Available

■ **MARKING**

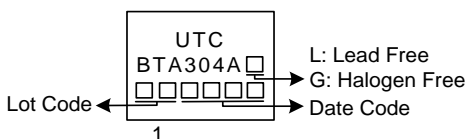

■ ABSOLUTE MAXIMUM RATINGS

PARAMETER		SYMBOL	RATINGS	UNIT
RMS On-State Current (360° Conduction Angle)	$T_C=90^\circ\text{C}$	$I_{T(RMS)}$	4	A
Non Repetitive Surge Peak On-State Current (T_J initial= 25°C)	$t_p=8.3\text{ms}$	I_{TSM}	42	A
	$t_p=10\text{ms}$		40	A
I^2t Value	$t_p=10\text{ms}$	I^2t	8	A^2s
Critical Rate of Rise of On-State Current: $I_G=50\text{mA}$, $dI_G/dt=0.1\text{A}/\mu\text{s}$	Repetitive $F=50\text{Hz}$	dI/dt	10	$\text{A}/\mu\text{s}$
	Non Repetitive		50	$\text{A}/\mu\text{s}$
Repetitive Peak Off-State Voltage ($T_J=125^\circ\text{C}$)		V_{DRM}/V_{RRM}	600	V
Peak Gate Current	$t_p=20\mu\text{s}$	I_{GM}	4	A
Peak Positive Gate Voltage	$t_p=20\mu\text{s}$	V_{GM}	16	V
Peak Positive Gate Power Dissipation	$t_p=20\mu\text{s}$	P_{GM}	40	W
Average Gate Power Dissipation		$P_{G(AV)}$	1	W
Operating Junction Temperature		T_J	-40 ~ +125	$^\circ\text{C}$
Storage Junction Temperature		T_{STG}	-40 ~ +150	$^\circ\text{C}$

Note: Absolute maximum ratings are those values beyond which the device could be permanently damaged. Absolute maximum ratings are stress ratings only and functional device operation is not implied.

■ THERMAL RESISTANCES

PARAMETER	SYMBOL	RATINGS	UNIT
Junction to Ambient	θ_{JA}	60	$^\circ\text{C}/\text{W}$
Junction to Case (AC)	θ_{JC}	2.7	$^\circ\text{C}/\text{W}$

■ ELECTRICAL CHARACTERISTICS ($T_J=25^\circ\text{C}$, unless otherwise specified)

FOR SNUBERLESS AND LOGIC LEVEL (3 QUADRANTS)

PARAMETER	SYMBOL	TEST CONDITIONS	SW			CW			UNIT
			MIN	TYP	MAX	MIN	TYP	MAX	
Gate Trigger Current	I_{GT}	$V_D=12\text{V}$ (DC)	I-II-III		10			35	mA
Gate Trigger Voltage	V_{GT}	$R_L=33\Omega$, $T_J=25^\circ\text{C}$	I-II-III		1.5			1.3	V
Gate Non-Trigger Voltage	V_{GD}	$V_D=V_{DRM}$, $R_L=3.3\text{k}\Omega$, $T_J=125^\circ\text{C}$	I-II-III	0.2			0.2		V
Time Gate Trigger	t_{GT}	$V_D=V_{DRM}$, $I_G=40\text{mA}$, $dI_G/dt=0.5\text{A}/\mu\text{s}$, $T_J=25^\circ\text{C}$	I-II-III		2		2		μs
Holding Current (Note 1)	I_H	$I_T=100\text{mA}$, Gate Open, $T_J=25^\circ\text{C}$			15			35	mA
Latching Current	I_L	$I_G=1.2I_{GT}$, $T_J=25^\circ\text{C}$	I-III		10			50	mA
			II		20			60	mA
Peak On-State Voltage (Note 1)	V_{TM}	$I_{TM}=5.5\text{A}$, $t_p=380\mu\text{s}$, $T_J=25^\circ\text{C}$			1.65			1.65	V
Repetitive Peak Off-State Current	I_{DRM}	V_{DRM} Rated, $T_J=25^\circ\text{C}$			0.01			0.01	mA
	I_{RRM}	V_{RRM} Rated, $T_J=125^\circ\text{C}$			0.75			0.75	mA
Critical Rate of Rise of Off-State Voltage (Note 1)	dV/dt	Linear Slope up to $V_D=67\%V_{DRM}$, Gate Open, $T_J=125^\circ\text{C}$		10			10		$\text{V}/\mu\text{s}$
Critical Rate of Rise of Off-State Voltage at Commutation (Note 1)	$(dV/dt)_c$	$(dI/dt)_c=1.8\text{A}/\text{ms}$, $T_J=125^\circ\text{C}$		1			1		$\text{V}/\mu\text{s}$

Note: For either polarity of electrode MT2 voltage with reference to electrode MT1.

■ TYPICAL CHARACTERISTICS

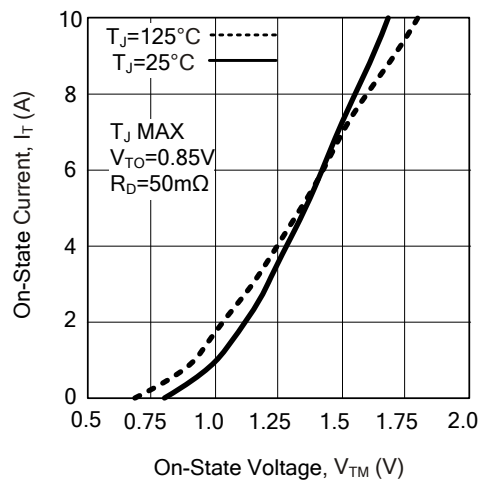
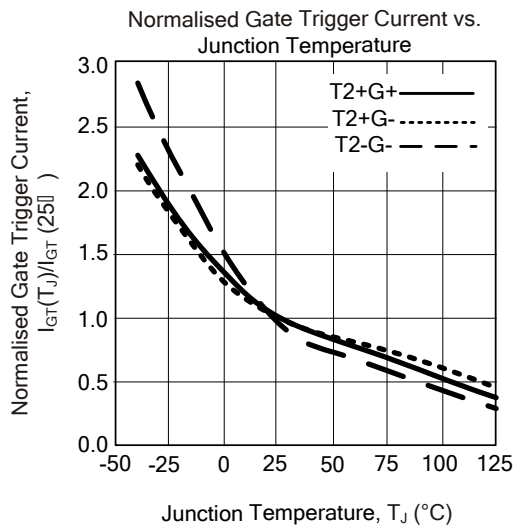
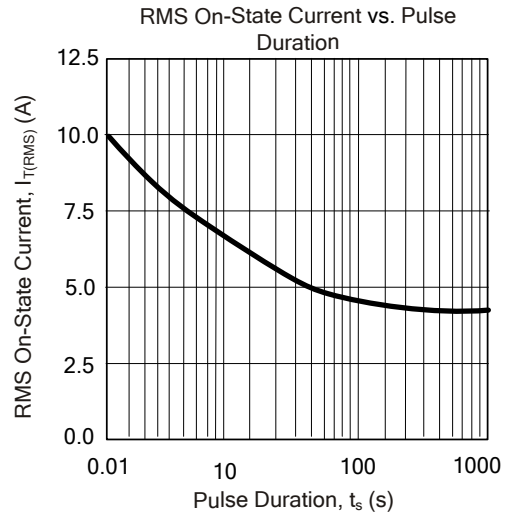
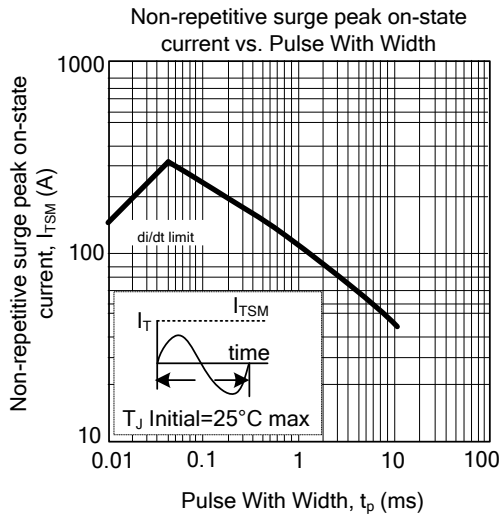
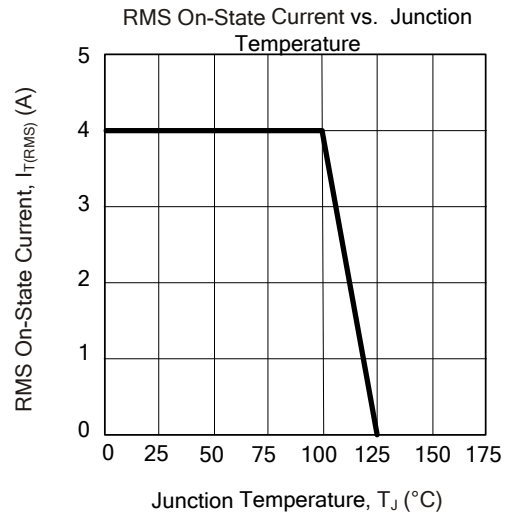
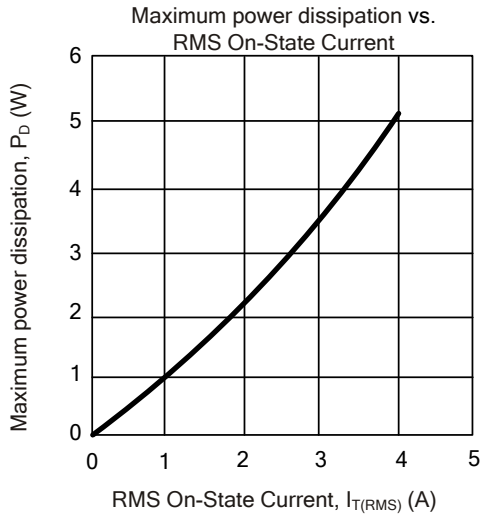

■ TYPICAL CHARACTERISTICS (Cont.)

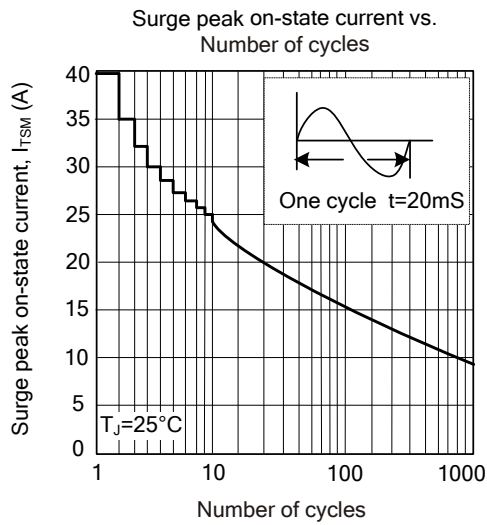

UTC assumes no responsibility for equipment failures that result from using products at values that exceed, even momentarily, rated values (such as maximum ratings, operating condition ranges, or other parameters) listed in products specifications of any and all UTC products described or contained herein. UTC products are not designed for use in life support appliances, devices or systems where malfunction of these products can be reasonably expected to result in personal injury. Reproduction in whole or in part is prohibited without the prior written consent of the copyright owner. UTC reserves the right to make changes to information published in this document, including without limitation specifications and product descriptions, at any time and without notice. This document supersedes and replaces all information supplied prior to the publication hereof.